

Klaus G. Wagner
Hydraulic Systems
Components and more



HANCHEN®

**Table of contents and chapter extract from the
book "Hydraulic Systems"
from Klaus Wagner**

german	978-3-9821291-0-5
english	978-3-9821291-1-2
french	978-3-9821291-2-9

Klaus G. Wagner
Hydraulic Systems
Components and more

This book was compiled by Herbert Hänchen GmbH & Co. KG.

Author:

Dipl.-Ing. Klaus G. Wagner is Head of Research and Innovation at Hänchen.

Proofreading:

Dipl.-Betrw. Sarah Bässler

Layout and design:

Klaus G. Wagner and Sarah Bässler

Photos and graphics:

Klaus G. Wagner and Beate Mayer

2nd extended edition 2019

This book is a completely revised and extended edition of
The Hydraulic Cylinder ... and more.

This book is a complete and adapted translation of the german edition of
"Hydraulische Systeme – Komponenten und mehr".

© 2019 Hänchen

All rights reserved by Herbert Hänchen GmbH & Co. KG, 73760 Ostfildern,
Germany

ISBN 978-3-98212911-2

HH2761 / 10-2019 em040223

This book is intended to provide an overview of hydraulic drive design, the relevant EC directives and associated standards. It is not intended as a complete guideline for the creation of CE documentation.

It is essential to study well the individual standards and guidelines.

The reproduction, distribution and utilization of this document as well as the communication of its contents to others without express authorization is prohibited. Noncompliance will result in Hänchen GmbH & Co. KG seeking damages. All rights reserved for patent, utility model or design application.

The hydraulic drive

“Please tell me which hydraulic drive I need. And what is the performance level of its cylinder. I need to know that for the machinery directive”.

It is not uncommon for machine engineers to ask such questions.

On closer inspection, it becomes obvious that there are differences in the market. Differences in quality, life time, free movement, service-friendliness and much more.

And that’s when you will ask – and rightly so: “What do I really need? Do I have to buy the most expensive thing or will a cheaper one do? How can I comply with the requirements? What do I do if I need more or less speed than usual?”

The engineer is obliged to carry out a risk assessment in addition to the technical design. In doing so, he determines which safety functions are needed to minimise the risk of endangering people. An example of such a safety function would be a protective fence around a press.

To assess the required types of protective measures, it is necessary to perform a performance level determination for the control functions. Protective measures must then be selected according to this required performance level.

Why all this? Because the law expects that people are able to work safely on the machine you designed.

And that is a good law. Imagine you have a daughter 16 years old. During the design phase, always ask yourself if you would allow her to work on this machine.

That’s why you should always think twice before using cheap components, because a slightly more expensive component could turn out to be the most inexpensive one after all.

Ostfildern, January 2017

The Hydraulic Drive 4.0

The world goes to extremes: everything keeps getting smaller, for example in electronics, whereas other things keep growing – for example, the construction of the Panama Canal to allow the passage of ever larger ships.

Modern vehicle components must be dynamically tested at ever increasing frequencies and with ever higher forces.

These extremes also find their way into hydraulic drive technology. Energy efficiency is also on everyone's lips these days.

Of course, even that applies to hydraulics. This will be clearly demonstrated in this second, extended edition.

A new section has also been added on the energy-efficient Servoseal® sealing system. Extensive recommended uses were described both for this and for the other systems.

The content has been greatly expanded to include the Machinery Directive and hydraulic control technology as a safety element with valve blocks and clamping units.

Hydraulic drives should become more efficient, more dynamic and safer.

This book is intended to give you some insight and help you achieve your perfect hydraulic drive.

To the second edition
Ostfildern, October 2019

Contents

Chapter 1: The hydraulic system	11
Hydraulic elements	12
Hydraulic fluid	13
Materials	14
Physical design	14
Chapter 2: The hydraulic cylinder	15
Classification of hydraulic cylinders	15
Type of effect	15
Working area	16
Series and working pressure	18
What's important?	21
Cylinder construction	25
Design	26
Chapter 3: Sealing elements for hydraulic cylinders	28
Static contact seals	29
Dynamic contact seals	31
Throttle gap seals	32
No-contact floating gap seal	34
Servoseal®	35
Wiper ring	36
Basic sealing materials	37
Chapter 4: Hydraulic cylinder equipment	39
Cover and piston type	39
Limits of application	39
Sealing system cover	41
Guiding system cover	43
Cover sealing and guiding system comparison	47
Sealing system piston	47
Guiding system piston	49
Piston sealing system comparison	50
Sealing material	50
Quality of piston rod	52
Chapter 5: Recommendations for use	54
Recommendation temperature	54
Recommendation series	54
Recommendation dynamics	55

Recommendation speed	57
Recommendation stroke and amplitude	58
Chapter 6: Calculation of hydraulic cylinders	60
Standard calculation	60
Drive power	60
Accelerated movement	61
Sine movement	64
Cylinders with control valves	65
Natural frequency	69
Side loads on the piston rod	73
Oil speeds	75
Buckling	76
Cushioning	77
Chapter 7: Energy efficiency	79
Energy efficiency by selecting the cylinder size	79
Energy efficiency by using accumulators	80
Friction of cylinders	80
Energy efficiency by choice of the sealing system	83
Energy efficiency by clamping	84
Energy efficiency by choice of the material	85
Chapter 8: Hydraulic cylinder operation	88
Mounting and start-up	88
Fluid cleanliness	88
Flushing the system	90
Venting	91
Chapter 9: Materials	92
Steel materials	92
Metallic lightweight design material	93
Fibre composite materials	93
Chapter 10: Fluids	95
Standards for hydraulic fluids	95
Mineral oils	96
Additives	96
Mineral oil-based hydraulic oils	98
Environment-friendly lubricating fluids	98
Fire-resistant hydraulic fluids	101
Other hydraulic fluids	101

Chapter 11: Sensors	102
Proximity switch	102
Position transducers	102
Inductive position transducers	104
Magnetostrictive position transducers	105
Force transducer	105
Mechatronics	106
Chapter 12: Piston rod clamping	107
Clamping unit Ratio-Clamp®	107
Equipment Ratio-Clamp®	108
Chapter 13: Safety as per EC directives	111
Placing on the market	111
Scope of application	111
Machinery Directive	111
Pressure Equipment Directive	112
EMC Directive	113
Low Voltage Directive	113
ATEX Directive	113
REACH Directive	114
Occupational Safety and Health Framework Directive	114
Chapter 14: Laws and standards	115
National law	115
Standards	115
Chapter 15: Applying the machinery directive	119
Conformity assessment procedures	119
Examples of the Machinery Directive in hydraulics	122
Risk reduction	125
Safety of the control system	126
Safety on the cylinder	131
Securing loads	132
Test operation	136
Retrofit – from old to new	137
Chapter 16: Safety by hydraulic control technology	138
Hydraulic blocks	138
Sandwich plates	140
Manifolds	140
Typical functions	141

Chapter 17: Application-specific design	146
Mounting with spherical bearings	146
Mounting with bending rod	149
Power transmission rods	149
Encased cylinders	150
Piston rod with anti-rotation mechanism	150
Lightweight design hydraulic cylinder	151
Pressure converter	152
Conduit pipes	154
Chapter 18: Acceptance and tests	155
Cylinder acceptance test	155
CE marking	155
GS mark	155
Further product testing	155
Chapter 19: Trivia et Varia	157
Contents of the EC Declaration of Conformity and Declaration of Incorporation	157
Terms used by the Machinery Directive	159
Conversion of units	160
Standards for hydraulic cylinders	161
Chapter 20: Further information	162
Standards for hydraulic cylinders	162
Safety technology standards	165
Hydraulic connection technology standards	167
EC Directives	168
Literature	169
Index	170

Chapter 1: The hydraulic system

When designing a hydraulic system, the engineer must take numerous aspects into consideration.

This includes first and foremost the physical and technical design of the drive, on which forces, speeds or acceleration rates are calculated.

The components and their designs must be specified depending on the purpose of application and the application of the drive.

The engineer must also design sealing systems to optimise leakage properties, energy balances and power losses.

The long service life of the system can be influenced by selecting the appropriate hydraulic fluid.

Besides these technical aspects, the engineer also has to consider legal issues. These include, for instance, the requirements of the German Product Safety Law.

The engineer must also be aware of the applicable standards and guidelines.

Here is an example: If a drive is expected to have a load-holding function, the engineer must consider the legal aspects concerning personnel risks and safety, and provide safety measures accordingly.

Redundant holding systems, consisting of hydraulic lock valves and clamping devices are often required.

This must be stated in the machine documentation, so that the operator can consider all issues which are of interest to him.

On the technical side, the engineer must, of course, select the optimal components and sealing systems for the special requirements of the load-holding function; and these should leak as little oil as possible in both the dynamic range and in the static state.

Hydraulic system design		
Physical design	Component selection	Legal issues
Force	Hydraulic drive system	EC Directives
Speed	Hydraulic fluid	Laws
Acceleration	Automation	Standards

Figure 1
Sample criteria for the hydraulic system design

Hydraulic elements

The hydraulic drive system of a machine generally consists of a pressure supply unit with a hydraulic pump and a hydraulic cylinder as a consumer, which converts the pump's hydraulic energy into mechanical energy.

The drive is controlled using control elements such as valves.

The safety-related considerations of a hydraulic system have to be made according to the components and their use and installation.

Pressure supply unit

The pressure supply unit forms the basis of any hydraulic system.

It consists of a tank with hydraulic fluid which is pressurised and sent to the consumer by means of a motor-pump-unit.

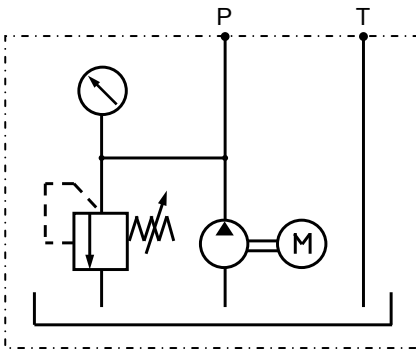

Figure 2
Hydraulic unit

The fluid is generally conditioned by means of an integrated filter and cooling system, and a safety valve for protection.

Hydraulic consumers

The hydraulic cylinder is a consumer and thus the power-transmitting element in a hydraulic system and produces a linear movement.

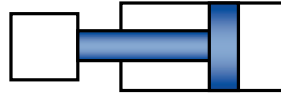

Figure 3
Hydraulic cylinder

This generates tensile and compressive forces corresponding to the hydraulic drive pressure and moves the piston rod at a speed corresponding to the flow rate.

Hydraulic drive elements for rotary or pivoting movements include, for instance, hydraulic motors.

The constructive design and quality features of hydraulic cylinders are described in Chapter 2: The hydraulic cylinder in detail.

Valve technology

Valves are control elements used for controlling consumers. For instance, directional valves determine the direction in which the cylinder moves.

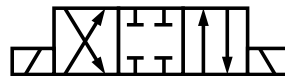

Figure 4
Hydraulic directional valve

Pressure valves such as pressure-limiting valves, regulate the pressure. Flow control valves control the flow rate. Lock valves block lines and thus secure the system from lowering, for instance.

For examples of valve controllers and valve blocks, please refer to Chapter 15: Applying the machinery directive.

Sensor technology

Measuring elements such as sensors measure physical parameters to monitor a hydraulic system or to trace data back to a control circuit.

Besides the position of the piston rod, even other parameters, such as forces, speeds, accelerations, pressures or temperatures are measured.

For information on sensors for hydraulic cylinders, refer to Chapter 11: Sensors.

Accumulator technology

A hydraulic accumulator stores a fluid under pressure. To do this, the fluid pressure compresses a gas, which expands when the fluid is withdrawn.

Hydraulic energy is released when unloading.

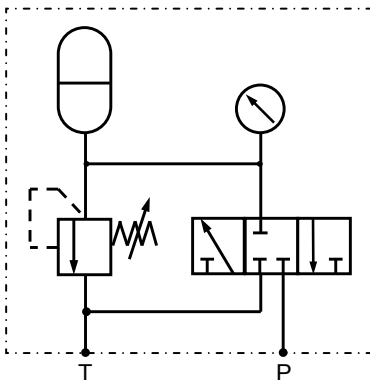

Figure 5
Hydraulic accumulator with safety block

Hydraulic accumulators enable energy to be stored very easily in hydraulic systems.

The use of accumulators and further measures for increasing the efficiency of hydraulic drives are described in Chapter 7: Energy efficiency.

Line construction

The term “Line construction” refers to the piping from the unit to the consumers. This is composed of hydraulic pipes or hoses.

Automation

By automating electronic components and software, a hydraulic system can perform complex sequences.

This also allows the creation of safe controls.

For further information on how to apply relevant laws and standards as well as the control’s requirements by determining the performance level, please refer to Chapter 13: Safety as per EC directives and Chapter 14: Laws and standards.

Chapter 15: Applying the machinery directive deals with the transposition of the requirements stipulated by the machinery directive.

Hydraulic fluid

Hydraulic drives require adequate fluids as per application case. When choosing a fluid, one needs to consider the requirements of the application, such as the temperature range, low inflammability in foundries or steel mills, or good biodegradability.

For further detailed notes, please refer to Chapter 10: Fluids.

Materials

To ensure that the drive operates reliably, it is essential that you select suitable component material. Various steel types, light-weight design materials or composites are used as per application case.

For further detailed information, please refer to.

Physical design

The design calculation of hydraulic cylinders is based on force and piston speed.

The respective surfaces, the hydraulic pressure in the cylinder and the available flow rate are crucial factors. For this, the admissible values for the working pressure in dependence of the pressure series and the admissible oil speed in the hydraulic ports must be taken into account.

The formulas for calculating the performance data for the different movements are described in Chapter 6: Calculation of hydraulic cylinders.

Chapter 2: The hydraulic cylinder

The hydraulic cylinder is a device for converting the pressure of a fluid, for example hydraulic oil, into a linear drive motion.

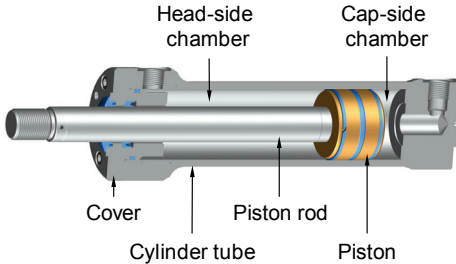

Figure 6
Components of a hydraulic cylinder

In piston cylinders, such as the hydraulic cylinders described here, the mechanical force is generated by the pressure of the transmission fluid to the piston surface. It is therefore a hydraulic linear motor.

A hydraulic cylinder consists of a cylinder tube, in which a piston rod with a piston moves back and forth. The ends of the

cylinder tube are covered with caps, or so-called covers.

The piston divides the interior of the cylinder into two chambers: the head-side and the cap-side chamber. Hydraulic pressure is applied to the piston and thus moves the piston rod.

Classification of hydraulic cylinders

Hydraulic cylinders are basically differentiated according to two different criteria: The type of effect and their design.

Type of effect

Regarding the type of effect, one distinguishes between double-acting and single-acting cylinders as well as in the pressurization of the working area.

In single-acting cylinders, the piston rod is extended (or retracted) by pressure on one working side, while the respective return stroke is caused by an external force, for example the dead weight or a spring.

Type of effect	
Working area	<div style="display: flex; justify-content: space-around; align-items: center;"> <div style="text-align: center;">  <p>Single-rod cylinder</p> </div> <div style="text-align: center;">  <p>Double-rod cylinder</p> </div> <div style="text-align: center;">  <p>Plunger cylinder</p> </div> <div style="text-align: center;">  <p>Synchronous cylinder</p> </div> </div>
Effective force	<div style="display: flex; justify-content: space-around; align-items: center;"> <div style="text-align: center;">  <p>Double-acting</p> </div> <div style="text-align: center;">  <p>Single-acting push</p> </div> <div style="text-align: center;">  <p>Single-acting pull</p> </div> </div>

Figure 7
Hydraulic cylinder classification

An application example for single-acting cylinders is a lifting platform for lifting loads by means of pressure where the retraction movement is caused by the dead weight of the load.

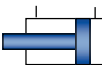
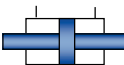
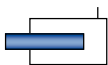
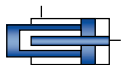
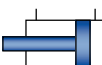
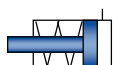
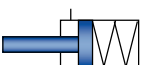
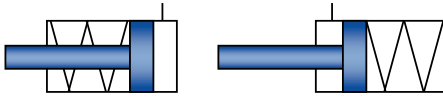

Figure 8

Left: single-acting cylinder under pressure
Right: single-acting cylinder under tension

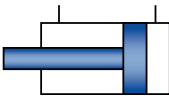

Figure 9

Double-acting cylinder

In double-acting cylinders, the piston rod is extended by pressure on one working side and retracted by pressure on the other working side. Double-acting cylinders are used more often.

Working area

The working area is a decisive factor for the physical design of a hydraulic cylinder. It is the surface on which the hydraulic pressure acts to produce the cylinder force.

Single-rod cylinders

Single-rod cylinders are cylinders with a one-side piston rod and thus with a large piston area for extension and an area for retracting that is reduced by the rod area.

Single-rod cylinders are also called differential cylinders, which, strictly speaking, is only correct if the ratio of the working areas is 2:1. Since this is often not the case, the term single-rod cylinder is more appropriate.

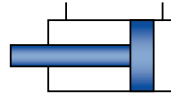

Figure 10

Single-rod cylinder

Regenerative circuit

Due to the area difference, pressurising both ports of a cylinder with a one-sided piston rod will cause an extending movement. The effective working area when extending A_{ext} is calculated using the piston surface A_1 and the annular surface A_2 to

$$A_{ext} = A_1 - A_2 \quad (1)$$

Cylinder with a through piston rod, i.e. with the same working area, cannot be operated with a regenerative circuit.

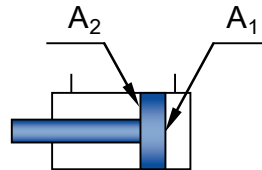

Figure 11

Working areas in the hydraulic cylinder

Therefore, the return flow from the head-side port is led into the cap-side port in a connection called a differential or regenerative circuit.

For the retraction of the cylinder, the effective working area A_{retr} is the same as the ring area A_2 .

$$A_{retr} = A_2 \quad (2)$$

The force exerted when extending the piston is reduced according to the ring area/piston area ratio. This generates high extension speed.

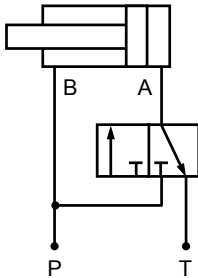

Figure 12
Hydraulic cylinder in regenerative circuit

In true differential cylinders, which are single-rod cylinders with an area ratio $\phi = 2$, the working areas in a regenerative circuit have the same size:

$$A_{retr} = A_{ext} \quad (3)$$

Assuming that the flow rate in a regenerative circuit remains unchanged, the cylinder will move at the same speed when retracting or extending, and the same force is exerted for extending and retracting.

Double-rod cylinders

Unlike single-rod cylinders, the surfaces for extension and retraction in a cylinder with a through piston rod, also called a double rod cylinder, are of the same size.

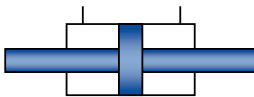

Figure 13
Double-rod cylinder

Especially in combination with symmetrical servo valves, surfaces of the same size allow realizing highly dynamic movements.

Due to the through rod, these cylinders are about twice the length of cylinders with one-sided piston rods.

Plunger cylinders

Plunger cylinders are cylinders without pistons and with only one working area, and they are therefore always single-acting.

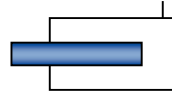

Figure 14
Plunger cylinder

The piston rod of a plunger cylinder is actually a plain rod without a piston. Within the cylinder, it is only supported by the guide in the cover and does not touch the inside of the tube. So these cylinders can only bear very low side loads.

Furthermore, these cylinders need an internal limit stop on the piston rod to prevent it from accidentally coming out of the cylinder completely. Otherwise, one has to ensure that an external limit stop is present during operation.

Synchronous cylinders

Synchronous cylinders have two surfaces respectively for retraction and extension which can be of the same size depending on the cylinder's construction. They are best suited for applications with dynamic movement.

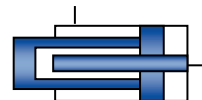

Figure 15
Synchronous cylinder

Due to their construction, however, they are about as long as single-rod cylinders.

Synchronous cylinders have two piston rods, a large one for transmitting power to

the outside, and a small one protruding into the large hollow rod.

The working areas in Figure 16, represented in dark green for retraction and extension, cause the large piston rod to move. The light green surface remains vented and is therefore not pressurised.

Chapter 7: Energy efficiency

One of the major advantages of hydraulics technology is that it enables energy to be easily accumulated. This means that hydraulic drives can be designed to be very energy efficient.

But even components have the potential of increasing energy efficiency.

A drive can be designed with better efficiency by selecting appropriate, low-friction sealing systems or by choosing the appropriate material.

Energy efficiency by selecting the cylinder size

The cylinder size is selected by calculating the forces and velocities as a function of pressure and flow rate.

But also external influences such as lateral forces or buckling have an influence on the cylinder size, especially on the diameter of the piston rod.

In order to design a cylinder energy-efficiently, the following relationships must be observed and checked:

The pressure should be as high as possible. This makes better use of the advantage of the energy density. Higher pressure results in smaller effective areas and thus smaller flow rates. Components such as valves or lines can be selected smaller and thus work more energy-efficiently.

The effective surfaces of the cylinders determine the force and the flow of the cylinder. Optimizing the effective area to the maximum force required as the upper limit is energy-efficient in the sense that smaller areas also require smaller volume flows so that the performance is optimized.

This can be achieved, for example, by dimensioning the piston of Series 320 cylinders with millimeter precision.

As shown as an example in the following diagram, a cylinder with a piston rod diameter of 40 mm and a standard piston dimension of 60 mm can be used for a desired nominal force of 10 kN. To achieve the speed of 1 m/s with this cylinder, a flow rate of approx. 94 l/min is required, the hydraulic power is calculated at 33 kW.

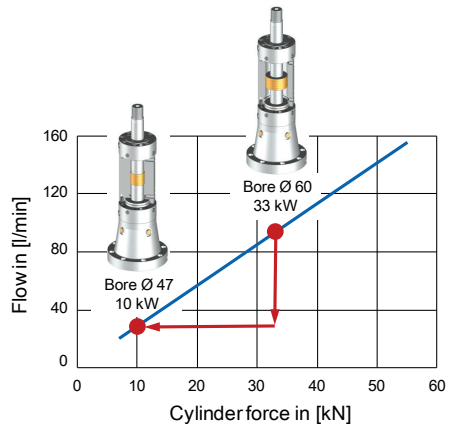

*Figure 129
Cylinder force and volume flow
Example for piston rods
Ø 40 mm, speed $v = 1$ m/s*

However, this standard size is too large for the required force. Optimization towards a force of 10 kN results in a piston diameter of 47 mm. Thus, the cylinder generates exactly the required force of 10 kN at 210 bar.

This reduced effective area reduces the volume flow rate to 29 l/min and the hydraulic power to 10 kW.

In addition to this energy saving, smaller components such as valves of nominal size 40 l/min can be used instead of 100 l/min.

But also by selecting the type of effect of the cylinder, the drive can be designed to be energy-efficient with standard dimensions.

If only a defined extending force is required, a single rod cylinder can be used. The irrelevant retracting force is then smaller according to the area ratio.

But if a defined retracting force is required, the use of a double rod cylinder with a through-going piston rod is more energy-efficient, since the large volume flow of the large cylinder surface does not have to be applied during the return stroke.

And even if symmetrical forces have to be applied, a synchronous cylinder is recommended from an energetic point of view.

Energy efficiency by using accumulators

By using hydraulic accumulators, it is possible to accumulate a hydraulic fluid under pressure in a gas-filled pressure vessel. The hydraulic fluid compresses the gas and is available indefinitely as stored energy.

The use of accumulators thus enables the efficiency of hydraulic drives to be increased, for example by designing the hydraulic unit for just an average requirement, but extracting peak power from an accumulator system.

The accumulator is then loaded when less energy is consumed.

Individual accumulators are merged into accumulator batteries to store a very large

amount of energy. Thus, many hundred litres of storage volume can be achieved.

This stored energy is also available in emergency mode when no drive energy is available.

Friction of cylinders

The friction force in hydraulic cylinders is one of the criteria for assessing the free movement.

Servo-dynamic applications in particular require free-moving hydraulic cylinders with little stick-slip.

Depending on the type of movement and on speed, temperature and pressure, the friction behaviour of hydraulic cylinders will vary. These factors have to be considered for the assessment of the cylinder.

Efficiency

The efficiency in general is the ratio of the power output and the power input. In hydraulic cylinders, the degree of efficiency is the product of the mechanical and the hydraulic efficiency.

The friction of the hydraulic cylinder is responsible for the cylinder's mechanical efficiency η_M .

This must be counted as a loss when calculating the cylinder's power and pressure. Also, one has to consider the hydraulic cylinder's friction loss depends largely on the size and properties of the piston rod. The piston itself has little influence on the friction force.

Leaking inside or out of the cylinder are responsible for the hydraulic efficiency η_H . This must be counted as a loss when calculating the cylinder's speed and flow rate.

The total efficiency η must be taken into account when determining the power.

$$\eta = \eta_M \cdot \eta_H \quad (54)$$

Mechanical efficiency

As described above, the efficiency is defined as the total efficiency resulting from the mechanical and the hydraulic efficiency. Leaking directly influences the hydraulic efficiency, while friction influences the mechanical efficiency.

The calculation of the mechanical efficiency is always based on the cylinder force F_Z , i.e. the difference between cylinder force and friction force F_R is put into relation with the cylinder force.

$$\eta_M = \frac{F_Z - F_R}{F_Z} \quad (55)$$

This makes the mechanical efficiency always directly dependent on the cylinder force and thus from the surface.

The friction force itself, on the other hand, depends almost entirely on the piston rod diameter with the seals in the cover, particularly in free-moving double rod cylinders with throttle-gap pistons. This makes an assessment of the cylinder on the basis of its efficiency rather difficult.

The following example shall illustrate this.

A cylinder of defined equipment and design has a bore D_k of 70 mm and a piston rod diameter d_s of 40 mm. The cylinder's friction force F_R measured in certain conditions is 250 N. The cylinder force at a pressure p of 210 bar is calculated to

$$F_Z = \frac{\pi}{4} \cdot (D_k^2 - d_s^2) \cdot p = 54,4 \text{ kN} \quad (56)$$

Therefore, the formula for calculating the efficiency is

$$\eta_M = \frac{F_Z - F_R}{F_Z} = 99,5 \% \quad (57)$$

This efficiency looks comfortably high, but it doesn't necessarily indicate cylinder's quality.

Looking at the same cylinder, with the same equipment and quality, but with a smaller bore D_k von 45 mm, one will find that the surface, and thus the cylinder force calculated accordingly, is reduced

$$F_Z = \frac{\pi}{4} \cdot (D_k^2 - d_s^2) \cdot p = 7 \text{ kN} \quad (58)$$

which reduces the efficiency

$$\eta_M = \frac{F_Z - F_R}{F_Z} = 96,4 \% \quad (59)$$

This example shows that the efficiency is no indicator for the quality of a hydraulic cylinder.

The value crucial for the assessment is, in fact, the friction force. This doesn't mean the friction force as an absolute quantity, but rather the independence of the friction force behaviour during the stroke, the independence of the pressure and the difference between static and sliding friction.

Static and sliding friction

According to VDMA 24577, the friction force of hydraulic cylinders is determined by differential pressure measurement in the electro-hydraulic control circuit. For this purpose, one has the piston rod of the hydro-cylinder travel within the position control-loop with the respective control valve and position transducer. Suitable pressure transducers are installed in both cylinder chambers, and the pressure dif-

ference is determined without load. This pressure difference is converted into a friction force via the surfaces.

Depending on the speed, the friction values will turn out differently. This solid friction, also called Coulomb friction, is divided into static friction, i.e. friction during standstill, and sliding friction, i.e. friction at the contact surfaces between objects moving relative to one another.

These don't always occur separately, they can occur at the same time or alternately as well. The stick-slip effect in hydraulic cylinders, for example, is a constantly alternating transition between static and sliding friction.

Therefore, when looking for a cylinder with little stick-slip, the crucial criterion is not necessarily a very low basic friction level, but rather a small difference between static and sliding friction.

Friction force comparison

The friction force comparison in Figure 130 shows friction values measured by way of example on a double-rod cylinder with a piston rod diameter of 40 mm. The values apply to one cover.

The 46 mm bore is sealed by a throttle gap. The values were determined in sine operation at 50 °C with HLPD 46 according to VDMA 24577.

The following properties are important when comparing the different cover types:

The sliding friction of the cover types with Servoslide® and Servocop® with contact seals is at a very low friction level. In both types, the friction increases with the chamber pressure. The PTFE compact seal in Servocop® further reduces static friction when compared to Servoslide®.

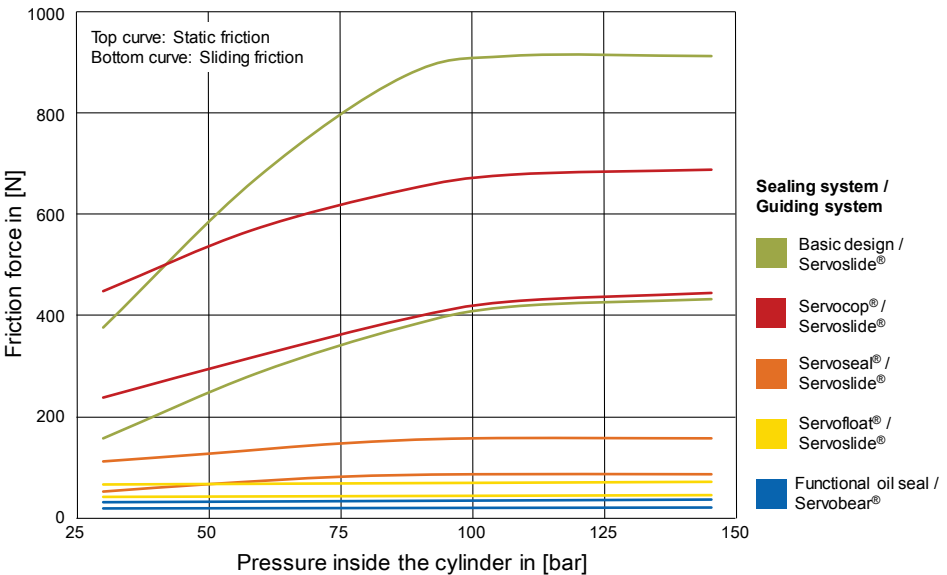

Figure 130 Friction force comparison of different cover types

The smaller the difference between static and sliding friction, the less the cylinder tends to exhibit stick-slip effects.

The no-contact cover types Servofloat® and Servobear® have an extremely low friction level. Their static and sliding friction are almost identical. The friction level of these no-contact cover types is not influenced by the chamber pressure and therefore remains constant even with continuously changing pressure.

The Servoseal® fits into the lower friction force range of well-known sealing and guiding systems. The pressure dependence of the friction is very low with Servoseal®.

Energy efficiency by choice of the sealing system

Every hydraulic cylinder needs a sealing system to discharge the pressure within the cylinder to the outside. Due to friction and leaking, this sealing system makes the cylinder lose energy.

The energy loss caused by friction force F_R depends on the piston speed v_k and the working pressure p_b in the chamber. On this basis, the power loss P_{vR} of contacting sealing systems by friction is calculated as follows

$$P_{vR} = F_R \cdot v_k \tag{60}$$

This needs to be taken into account, for example, for cylinders with the Servocop® sealing system.

No-contact sealing systems such as Servofloat® require a functional oil flow Q_L generating a loss of energy in dependence on the piston speed v_k and the working pressure p_b in the chamber.

This leaking fluid must be led into the cylinder through the valve as an additional volume flow. The power loss P_{vR} of no-contact sealing systems is calculated as follows

$$P_{vL} = Q_L \cdot p_b \tag{61}$$

making the total power loss P_v

$$P_v = P_{v,R} + P_{v,L} \tag{62}$$

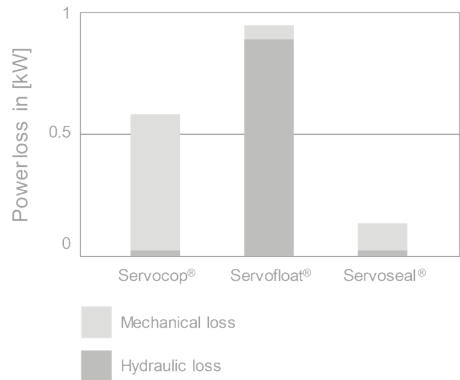

Figure 131
Power loss comparison

For example, the mechanical power loss of the Servoseal® is approximately the same as with gap seals, for example Servofloat®. And the hydraulic power loss is comparable to conventional seals such as Servocop®.

The addition of the power losses results in a total power loss, which is very low with the Servoseal®.



HÄNCHEN®

Herbert Hänchen GmbH & Co. KG

Brunnwiesenstr. 3, 73760 Ostfildern
Postfach 4140, 73744 Ostfildern
Fon +49 711 44139-0
info@haenchen.de, www.haenchen.de

ISBN 978-3-98212911-2

